

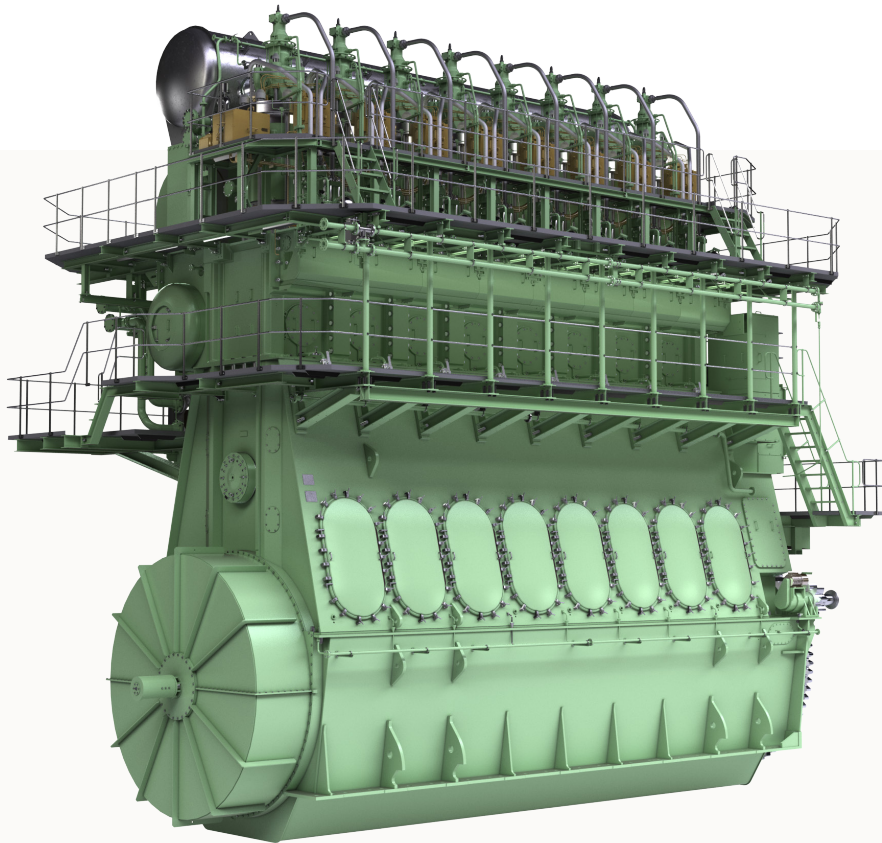

CJC® Oil Filtration & Purification Systems for

Marine Engine Lube Oil

A revolutionary solution - from the Oil Filtration Experts



"Stop Running in Circles"

Start maintaining your lubricants with this revolutionary
CJC® Engine Lube Oil Treatment Solution
- reducing maintenance, fuel consumption and CO₂

A revolutionary technology from CJC® It may change the way you think

It's not just about the lube oil
- it's about the savings and the carbon footprint

Lube oil is the lifeblood of engines and it must be maintained clean, dry and in a proper chemical condition to fulfil its purpose and protect the engine. Because of this, technical aspects have always been at the centre of your and our attention, but now we want you to change your focus – the ROI of this ground breaking technology will inspire you.

With the right maintenance strategy, it is possible to keep 2- and 4-stroke engines at optimum reliability and constantly optimize TBO (Time Between Overhaul) and OPEX (Operating Expenses).

OEM Cooperation

An example of our cooperation with OEMs is seen with the promotion agreement with MAN PrimeServ OmniCare.

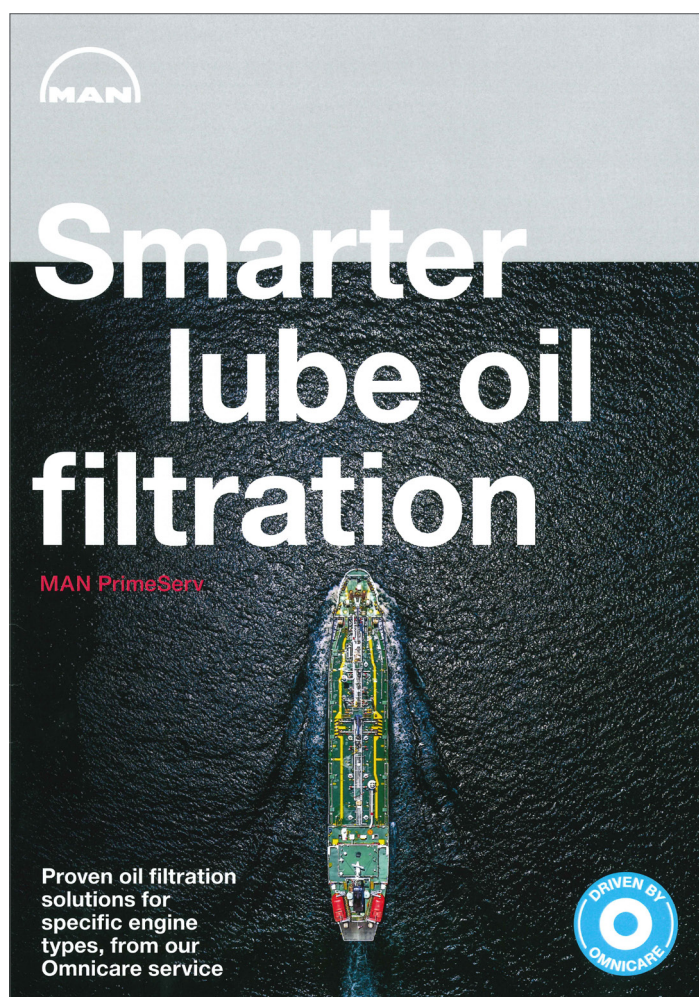

MAN PrimeServ Omnicare brochure, describing the partnership and CJC® Engine Lube Oil technologies.

Engine Makers and organizations such as CIMAC have issued recommendations for oil analysis and condemning limits, that ensure oil and engine reliability and uptime. If these recommendations are not followed, risks of operational and financial damages are incurred.

Engines are usually equipped with centrifugal separators, and in-line automatic filters to comply with recommendations. The centrifugal separators are expensive to operate, but there is an alternative. The solution is based on a decade of extensive research and trials with major shipowners and engine makers, audited by independent consultants specialized in energy saving - a ground breaking and sustainable system technology providing first class results and cost-saving.



CIMAC 4-stroke Condemning Limits

Property	Method	Unit	Precautionary action	Mandatory action
Viscosity	ISO 3104	mm ² s ⁻¹ @ 40°C	- 25% / + 25%	- 25% / + 45
		mm ² s ⁻¹ @ 100°C	- 15% / + 15%	- 20% / + 25
Base Number	ISO 3771	mg KOH/g	- 40%	- 50%
Water content	ISO 3733	% v/v	> 0.2	> 0.4
Flash point	ISO 2719	°C	< 190	< 170
n-pentane insolubles	ASTM D893B	% m/m	> 1.5	> 2.0

CIMAC 2-stroke Condemning Limits:

Property	Method	Unit	Mandatory action
Viscosity @ 100 °C	ISO 3104	mm ² s ⁻¹	max. 3.0-3.5 decrease
Acid Number	ASTM D664	mg KOH/g	max. 2.0 KOH/g increase
Base Number	ISO 3771 / ASTM D2896	mg KOH/g	min. 3.0 max. 30
Water Content	ISO 3733 / ASTM D1744	% v/v	max. 0.2
Flash Point	ISO 2719 / ASTM D3828	°C	min. 180
n-pentane and toluene insolubles	ASTM D893B	% m/m	max 1.5

CJC[®] Engine Lube Oil Treatment Your Compliance Guaranteed

In an industry driven by tradition and compliance, how do new technologies gain a foothold?

Most marine systems rely on a set of parameters laid out by class and/or OEMs, and marine engine lube is one of the most rigid. Following the guidelines, makes it easy to document that the shipowner has taken relevant action to ensure proper and safe operation of the vessel. This philosophy also makes it easy for suppliers to know what a new technology must comply to.

At C.C.JENSEN, we also rely on technologies proven over many years, and when developing this system solution, we needed to prove our worth in a real-life trial in order to gain a foothold. We therefore decided to test our CJC[®] Engine Lube Oil Treatment Solution - to analyse **what the effects would be on:**

Additives

- Wear and fuel elements
- Water and TBN
- Viscosity and insolubles

The installation was in parallel to conventional technologies, as can be seen from the diagram below, but with only the CJC[®] solution operating. After 5,000 hrs trial and documentation, the result was a "No Objection Letter" from the engine maker, and implementation in guidelines from top engine makers.

The installation of the CJC[®] Engine Lube Oil Treatment solution uses existing piping and just needs electrical wiring and is thereby as simple and easy as possible to install. Please ask us for an Installation Guide, to see how easy it is.

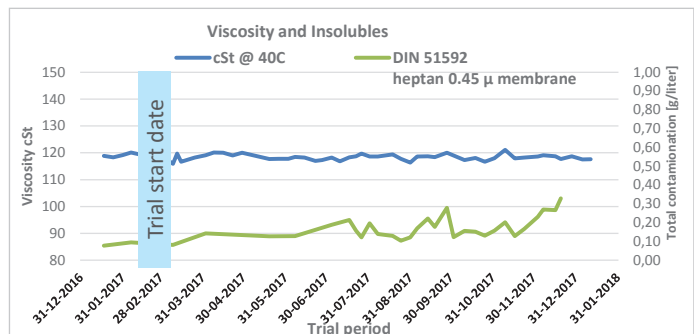
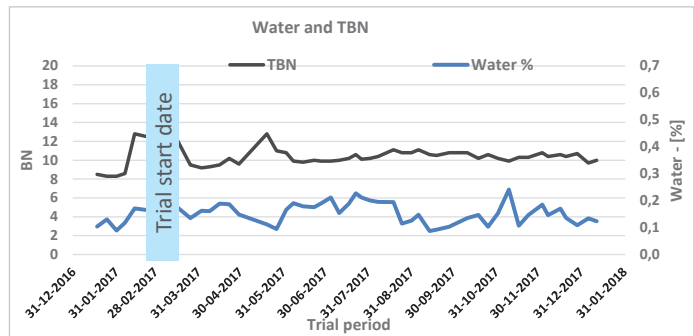
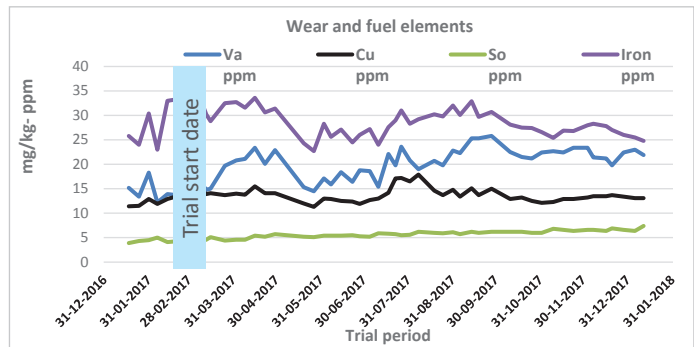
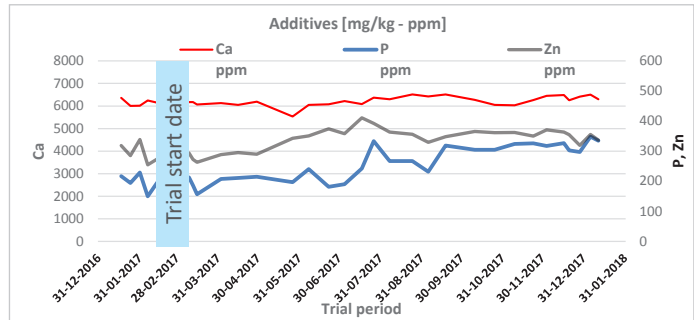
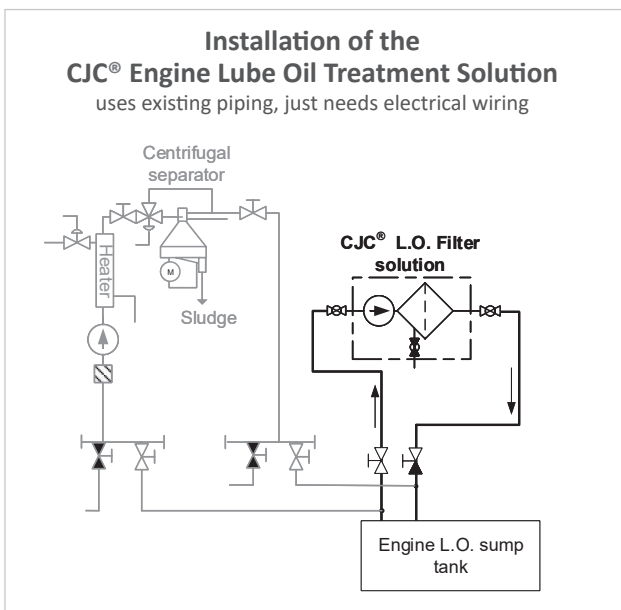

Customer Case: Supply Vessel

Supply Vessel Shipowner, Denmark

Application: ME 4-stroke, medium speed, operating on MGO



It's not just about the lube oil, it's about the savings and the carbon footprint.

CJC® Engine Lube Oil Treatment Solution benefits both the environment and OPEX positively.

Problem

One of the major Danish shipowners experienced high oil consumption due to frequent top-up, too high manpower for maintenance, almost 8,000 l of sludge to be disposed of, and an energy consumption of 235,655 kWh per year. All in all, not a financially viable or sustainable set-up.

Solution

The CJC® Engine Lube Oil Treatment Solution was installed as an alternative to the more traditional technologies - centrifugal separator - on one of the main engines. The goal was to compare not only the oil cleanliness, dryness and oxidation level, but also to measure the implications on the operation and financial parameters.

After 10,000 hours of operation, the conclusion was clear; the innovative and ground breaking technology from CJC® had proven its worth.

Results per engine

- 60% reduction in man-hours for maintenance
- 60% reduction in oil consumption - 9,000 l/yr
- 99.7% sludge reduction - 7,641 l/yr
- 97.6% reduced energy consumption - 229,961 kWh/yr
- 97.6% reduction in carbon footprint - 140T/yr
- 11.5 months payback time



Our customer is one of the major Danish shipowners

Customer Case: Container Vessel

Container Vessel Shipowner, Germany

Application: 5,000 hours trial MAN B&W 11K 98ME-MK7

Copenhagen, 20 December 2018

**No objection letter for CC Jensen system lubricating oil filter
CJC filter type: Marine Lube Oil Purifier 27 or 427 with LOX elements
Two-stroke engines: All types and fuels**

A 46-week trial verified the effects on the engine lube oil quality of the CJC® solution

CJC® Engine Lube Oil Treatment solution keeps the oil in perfect condition

Problem

Many shipowners are very concerned about keeping their engine lubes in a quality that warrants compliance with CIMAC and Engine Manufacturers. At the same time, they are looking for financial and environmental savings.

Solution

The CJC® Engine Lube Oil Treatment Solution was installed - as an alternative to the more traditional technologies - on a MAN 2-stroke low speed diesel engine to analyse if the characteristics of the lube oil would change.

After 5,000 hours of operation, the conclusion was clear; the technology from CJC® kept the lube oil characteristics in condition for further use, and it would reduce energy consumption and improve financial gains.

Technical results

- **Constant** additive content
- **Constant** viscosity and insolubles
- **Constant** water and TBN
- **Constant** wear and fuel elements

All within CIMAC condemning limits.

Financial results

- **10-20%** saving in SLOC - 20-30 l/24h
- **<10,000 kWh** energy consumption/yr
- **150T CO₂** emissions saved/yr
- **7 months** payback time



C.C.JENSEN works with the world's largest shipowners

Customer Case: Tanker Vessel

Tanker Vessel Shipowner, Denmark

Application: 4-stroke trunk diesel engine operated on HFO



The CJC® Engine Lube Oil Treatment solution also works with HFO

Test on 5 vessels and 15 generating sets proved economical benefits. The crew involved were very positive.

Problem

A Danish tanker vessel shipowner was aiming to save DRC (Direct Costs) in the range of 15,000 USD per year by installing the CJC® Engine Lube Oil Treatment solution. The assumption was also that it would be equal to or better than conventional technologies - centrifugal separator - in maintaining oil, and that it would be easy to install. Three dedicated CJC® Oil Filters replaced one shared separator for three engines.

Solution

The CJC® Engine Lube Oil solution was installed and tested on five different vessels with MAN 23/30H 800/960 kW and Yanmar GN2/AL-SV 900 kW running on HFO or LSHFO. After 10,000 hours of operation the conclusion was that the technology from CJC® had proven its worth in a financial business case.

Results

Among other positive effects, the small by-pass centrifuge was inspected before and after 3,000 hrs of trial, and the sludge layer was proven reduced from 5 mm to 0 mm. Service life of the CJC® Filter Inserts was in average 9 months, and oil characteristics were improved, e.g. vanadium levels improved by a factor 5.

Overview of savings:

- 60% reduction in man-hours for maintenance
- 60% reduction in oil consumption - 4-6000 l/yr
- 99.7% sludge reduction - 4-6000 l/yr
- 97.6% reduced energy consumption - reduced to 7,776 kWh/yr
- 97.6% reduction in carbon footprint - reduced to 2T/yr
- 14 months payback time

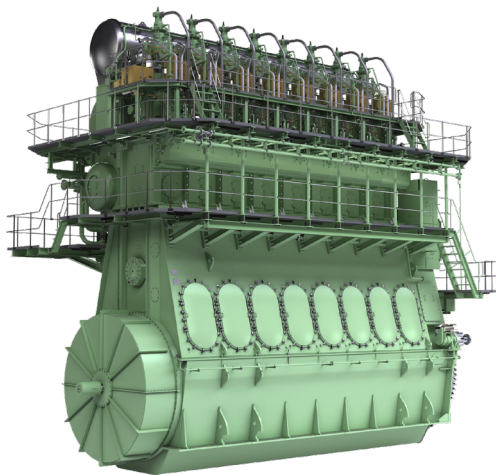

Our customer is one of the major Danish tanker shipowners

Your Solution CJC® Engine Lube Oil Filtration

It's not just about the lube oil,
it's about savings & carbon footprint

The bulk of costs for maintaining engine lube oil clean and dry is energy and oil consumption.

ROI Calculation Tool

To make it easy for you to precisely calculate ROI on retrofitting the CJC® Engine Lube Oil Filter, C.C.JENSEN has developed a very simple and verified calculation model that can be used for all 2- and 4-stroke engines. Numerous calculations carried out so far have shown a **payback time of 6-18 months**, and we invite you to contact us, to make a specific calculation for your system in a short phone call.

CJC® Engine Lube Oil Treatment solution

This CJC® Engine Lube Oil Filter is installed offline, similar to the centrifugal separator with its own pump. The main advantage, however, is that installation, operation and maintenance is much easier. The CJC® FlowDrive features automatic adjustment of the cleaning capacity to ensure efficient and economic cleaning and maintenance of the main lubricating oil system. Along with the CJC® FlowDrive, the genuine CJC® Filter Inserts type LOX, LO4R and LO4D facilitate continuous and uncomplicated operation during sea passage, manoeuvring, and port stay. The outstanding high dirt holding capacity ensures very long lifetime of the CJC® Filter Inserts. The simplicity of the complete system makes it ideal for retrofit installations as well as for new-building projects. Extensive field trials with major shipowners have proven >100% availability of the system and continuous compliance with lube oil condition requirements. User feedback has shown that land-based operators and vessels crews are thrilled to work with the system. They point to the simplicity and results compared to conventional technologies.

Up to 2% CII improvements - Case example based on a real-life case:

A 46,921 DWT Tanker running with HFO, with a speed of 13 [knots], main engine running hours of 3,600 [hrs./Year] and total fuel oil consumption of 4,622 [mT/year], the attained CII is 6.55 [gCO₂/tnm]. By implementing the CJC® Solution, the vessel saved 80.36 [mT/year] of fuel and the new attained CII is 6.44 [gCO₂/tnm], and hence a **fuel oil consumption saving and a CII Improvement of 1.74%**.

All CJC® Solutions for marine and offshore comply with IACS class rules and maritime regulations including requirements to materials certificate, Class II and III piping, SOLAS requirements, applied standards on steel and pipe work, and welding procedures. Naturally, we also comply with OEM requirements, which can be seen from the "No Objection Letters" we received from a major Engine Manufacturers.



CJC® Engine Lube Oil Filter &
CJC® Filter Inserts: LO4D, LO4X & LOX

With the CJC® Solution you will:

- Reduce OPEX through energy and oil savings
- Comply with engine lube standards on 2- and 4-stroke engines

Applicable for both New-build and Retrofit:

- 2-stroke engines, all types of fuel
- 4-stroke engines, residuals
- 4-stroke engines, distillates & gas

Benefits:

- 97% energy savings
- 97% CO₂ savings
- Up to 60% less oil consumption
- 99% lube oil sludge reduction
- Up to 2% CII improvement

Proven in extensive trials by third party consultants over the past years.

Verified and approved by both major engine makers and class societies.



Letter of no
Objection,
WinGD.

C.C.JENSEN

- contact us today!



Manufacturing & headquarters















C.C.JENSEN A/S

Løvholmen 13 | DK - 5700 Svendborg | Denmark

Tel. +45 6321 2014

sales@ccj.dk | www.cjc.dk

The C.C.JENSEN Marine & Offshore team is ready to calculate YOUR Cost and Energy Savings - *just call us!*

- | | | | | | | | |
|---|--|---|--|---|---|---|---|
|  |  |  |  |  |  |  |  |
| Kim Kjær
+45 2222 2967
kk@ccj.dk
C.C.JENSEN A/S
Denmark | Gustav H. Frederiksen
+45 4121 7308
ghf@ccj.dk
C.C.JENSEN A/S
Denmark | Natasha Knudsen
+45 2222 2964
nj@ccj.dk
C.C.JENSEN A/S
Denmark | Christopher Alnor
+45 7228 2245
ca@ccj.dk
C.C.JENSEN A/S
Denmark | Reza Azimi-Vishteh
+45 6091 6331
raz@ccj.dk
C.C.JENSEN A/S
Denmark | Bjørn G. Martinsen
+45 2222 2991
bgm@ccj.dk
C.C.JENSEN A/S
Denmark | Torben Andersen
+45 4028 4170
tan@ccj.dk
C.C.JENSEN A/S
Denmark | Josh Wardell
+45 6091 6297
jjw@ccj.dk
C.C.JENSEN A/S
Denmark |
|  |  |  |  |  |  |  |  |
| Theodor Shahen
+49 151 463 124 56
tsh@ccj.dk
C.C.JENSEN A/S
Denmark | Leonardo D'Andrea
+55 21 99701 2018
lgd@ccjensen.com.br
C.C.JENSEN Brazil
Brazil | Jérôme Leclaire
+33 788 558 609
jle.fr@ccj.dk
C.C.JENSEN France
France | Marco van Boven
+31 612142130
mbv.nl@ccj.dk
C.C.JENSEN Benelux
The Netherlands | Rob Ramsteijn
+31 619617906
rr.nl@ccj.dk
C.C.JENSEN Benelux
The Netherlands | Jesper Skov
+1 713 542 6124
jesper@ccjensen.com
C.C.JENSEN Inc.
USA | Vinod Jacob
+97 14 44 72 886
vij@ccj.dk
C.C.JENSEN Middle East
UAE | Andy Knox
+44 7399 2997 08
andy.knox@ccjuk.co.uk
C.C.JENSEN Ltd.
United Kingdom |



Scan the QR code and find your nearest **CJC® Distributors** at www.cjc.dk/contact - or just call us!



EPS
Enhanced Performance Solutions Sdn Bhd 749579 K
11, Jalan Putra Perdana 1/2, Taman Putra Perdana
47100 Puchong, Selangor Darul Ehsan
T.03 83251531 F.03 83251731
sales@epsmy.com / sofian@epsmy.com www.epsmy.com

C.C.JENSEN A/S
www.cjc.dk

